

- **Description:**

Highly sensitive triggering levels, the MCR100-6 Series SCRs is suitable for all applications, where the available gate current is limited, such as capacitive discharge ignitions, motor control in kitchen aids, overvoltage crowbar protection in low power supplies...

- **Features:**

Blocking voltage to 400V
 On-state RMS current to 0.8A
 Non-repetitive peak on-state current to 9A

- **Absolute Maximum Ratings**

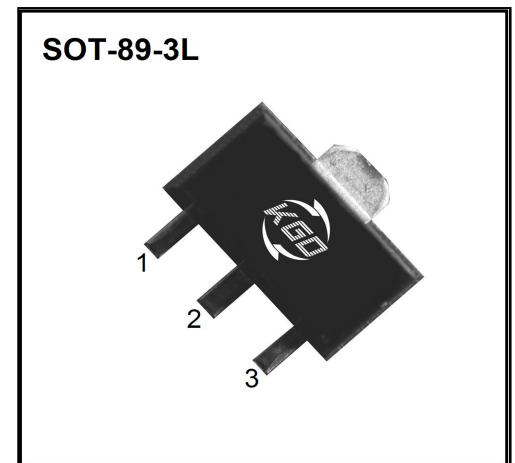

Symbol	Parameter	Conditions	Value	Unit
V_{DRM}	Repetitive peak off-state voltage	$T_J=25^\circ\text{C}$	400	V
V_{RRM}	Repetitive peak Reverse voltage	$T_J=25^\circ\text{C}$	400	V
$I_{T(RMS)}$	RMS on-state current (180° conduction half sine wave)	$T_c=77^\circ\text{C}$	0.8	A
$I_{T(av)}$	Average on-state current (180° conduction half sine wave)	$T_c=77^\circ\text{C}$	0.5	A
I_{TSM}	Non-repetitive surge peak On-state current ($T_J=25^\circ\text{C}$)	$t_p=10\text{ms}$	9	A
		$t_p=8.3\text{ms}$	10	
I^2t	I^2t Value for fusing	$t_p=10\text{ms}$	0.415	A^2S
I_{GM}	Peak gate current	$t_p=20\mu\text{s}, T_J=110^\circ\text{C}$	0.2	A
$P_{G(AV)}$	Average gate power dissipation		0.1	W
T_{STG}	Storage temperature		-40 150	$^\circ\text{C}$
T_J	Junction temperature		-40 110	$^\circ\text{C}$

● Electrical Characteristics

Symbol	Conditions	Value			Unit
		MIN	TYP	MAX	
I_{GT}	$V_D=6V, R_L=100\Omega$	/	40	200	μA
V_{GT}		/	0.6	0.8	V
V_{GD}	$V_D=V_{DRM}, R_L=3.3K\Omega, R_{GK}=1K\Omega, T_J=110^\circ C$	0.2	/	/	V
I_L	$I_G=1mA, R_{GK}=1K\Omega$	/	/	6	mA
I_H	$I_T=50mA, R_{GK}=1K\Omega$	/	/	5	mA
dv/dt	$V_{DM}=67\%V_{DRM}, R_{GK}=1K\Omega, T_J=110^\circ C$	10	/	/	$V/\mu s$

● Electrical Characteristics

Symbol	Parameter	Numerical(Max)	Unit
V_{TM}	$I_T=1A, t_p=380\mu s$ $T_J=25^\circ C$	1.7	V
I_{DRM}	$V_D=V_{DRM}, V_R=V_{RRM}$ $T_J=25^\circ C$	5	μA
I_{RRM}	$T_J=125^\circ C$	0.1	mA

● Thermal Characteristics

Symbol	Parameter	Numerical(MAX)	Unit
$R_{th(j-c)}$	Junction to case SOT-89-3L	15	$^\circ C/W$
$R_{th(j-a)}$	Junction to ambient SOT-89-3L	400	$^\circ C/W$
T_L	Lead Solder Temperature(<1/16" from case, 10 secs max)	260	$^\circ C$

● Package Outline Dimensions

SOT-89-3L

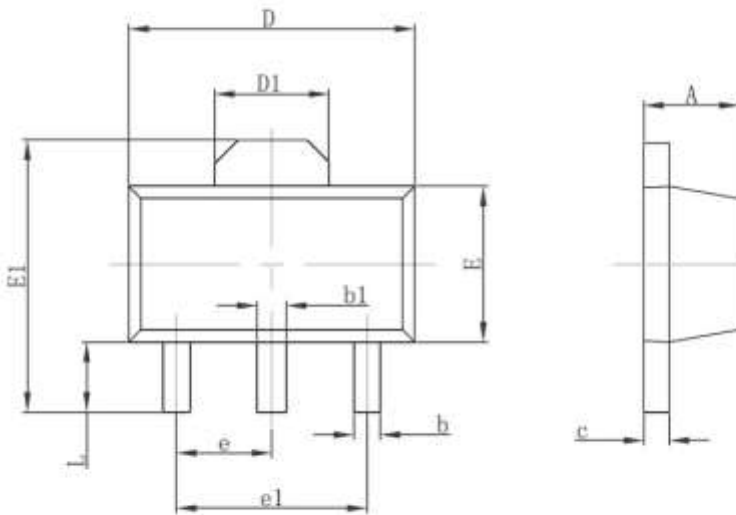

Ref.	Dimensions			
	Millimeters		Inches	
	Min.	Max.	Min.	Max.
A	1.400	1.600	0.055	0.063
b	0.320	0.520	0.013	0.020
b1	0.400	0.580	0.016	0.023
c	0.350	0.440	0.014	0.017
D	4.400	4.600	0.173	0.181
D1	1.550 REF.		0.061 REF.	
E	2.300	2.600	0.091	0.102
E1	3.940	4.250	0.155	0.167
e	1.500 TYP.		0.060 TYP.	
e1	3.000 TYP.		0.188 TYP.	
L	0.900	1.200	0.035	0.047

● Marking

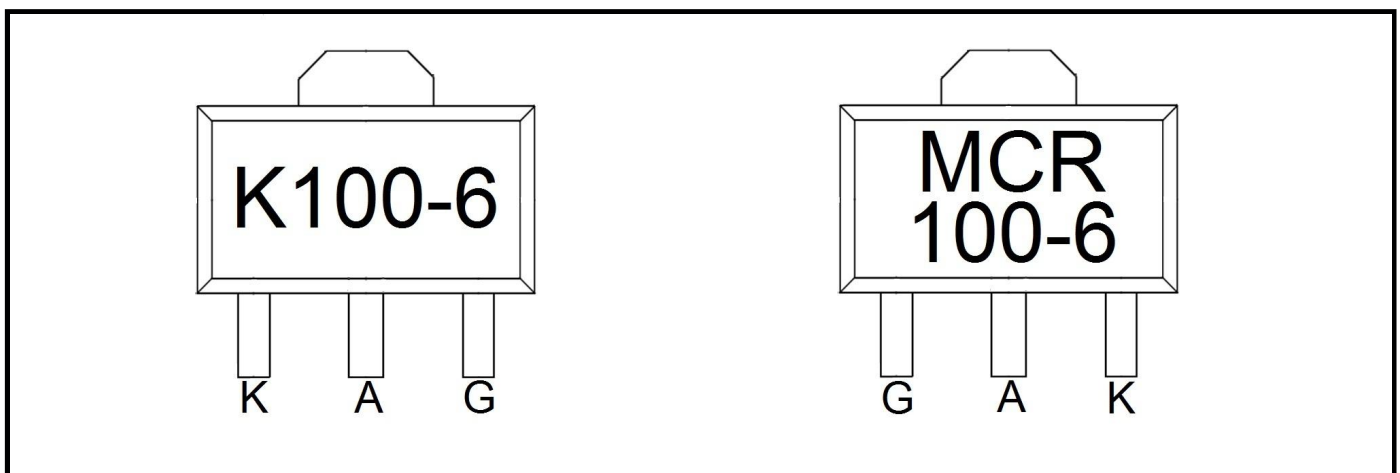
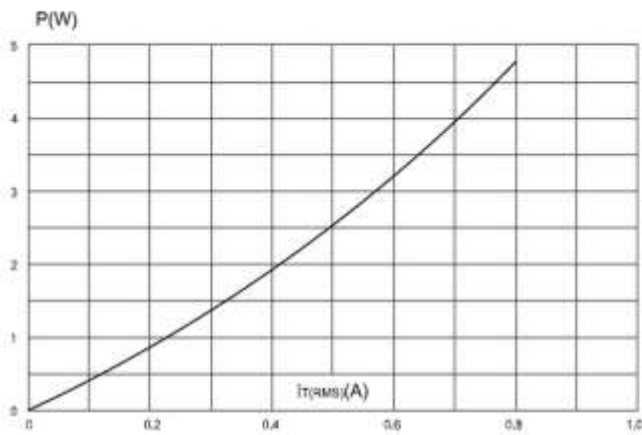
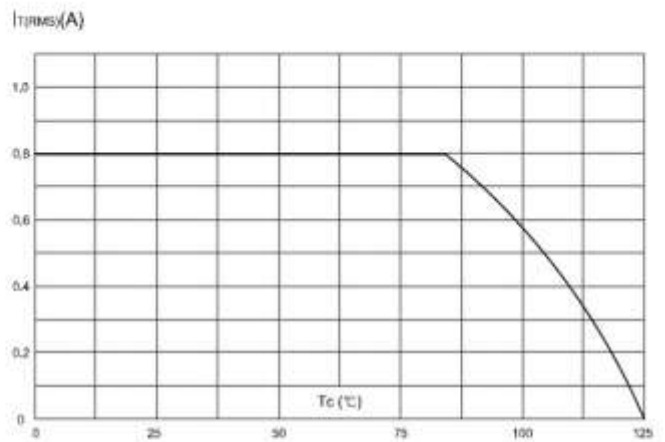
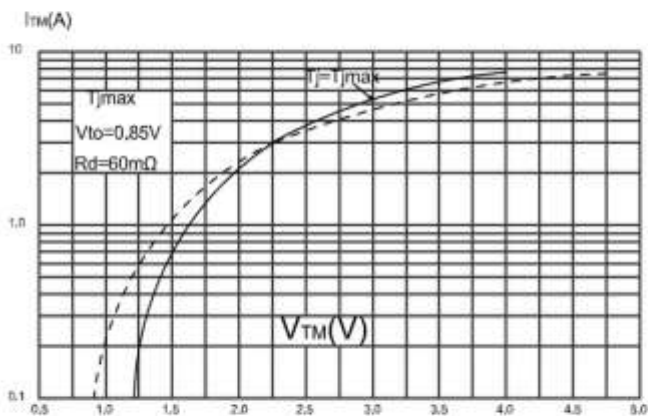
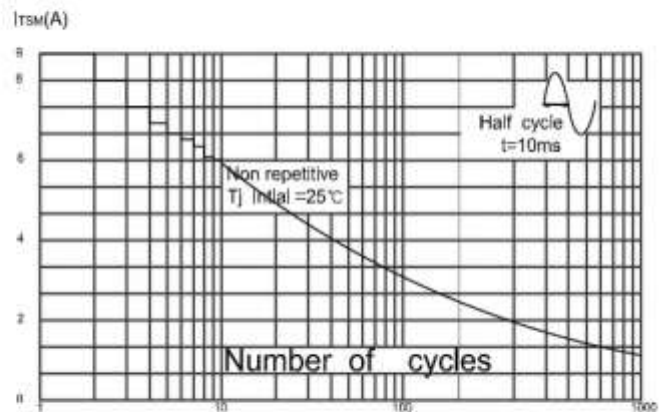
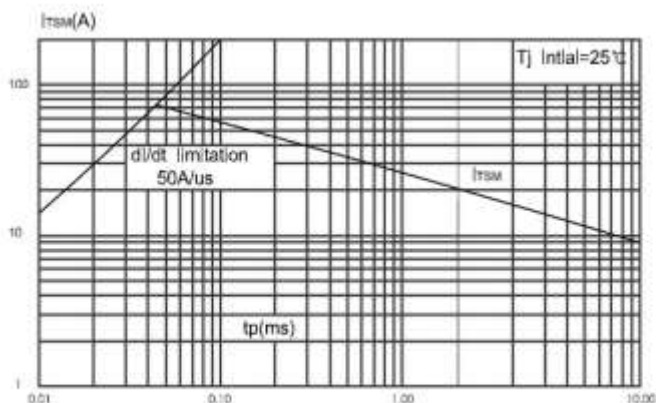

FIG.1: Maximum power dissipation versus RMS on-state current(full cycle)

FIG.2: RMS on-state current versus case temperature(full cycle)

FIG.3: On-state characteristics (maximum values)

FIG.4: Surge peak on-state current versus number of cycles.

FIG.5: Non-repetitive surge peak on-state current for a sinusoidal pulse with width $t_p < 10ms$.

FIG.6: Relative variation of gate trigger current, holding current and latching current versus junction temperature(typical values).
